

Feature

- For surface mounted applications
- Low profile package
- Glass Passivated Chip Junction
- Easy to pick and place
- High efficiency
- Lead free in comply with EU RoHS 2011/65/EU directives

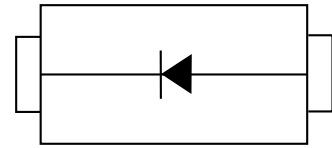

Mechanical Characteristics

- Case: SMAF
- Terminals: Solderable per MIL-STD-750, Method 2026
- Approx. Weight: 27mg 0.00086oz

Absolute maximum rating@25 °C

Parameter	Symbol	PUS2 AF	PUS2 BF	PUS2 DF	PUS2 GF	PUS2 JF	PUS2 KF	PUS2 MF	Units
Maximum Repetitive Peak Reverse Voltage	V_{RRM}	50	100	200	400	600	800	1000	V
Maximum RMS voltage	V_{RMS}	35	70	140	280	420	560	700	V
Maximum DC Blocking Voltage	V_{DC}	50	100	200	400	600	800	1000	V
Maximum Average Forward Rectified Current at $T_a = 65\text{ °C}$	$I_{F(AV)}$	2							A
Peak Forward Surge Current 8.3 ms Single Half Sine Wave Superimposed on Rated Load (JEDEC Method)	I_{FSM}	50							A
Maximum Instantaneous Forward Voltage at 2A	V_F	1.0		1.4		1.7			V
Maximum DC Reverse Current $T_a=25\text{ °C}$ at Rated DC Blocking Voltage $T_a=125\text{ °C}$	I_R	5 100							μA
Maximum Reverse Recovery Time ¹⁾	t_{rr}	50				75			nS
Typical Thermal Resistance ²⁾	$R_{\theta JA}$	50							$^{\circ}C / W$
Operating and Storage Temperature Range	T_j, T_{stg}	-55 ~ +150							$^{\circ}C$

Typical Characteristics

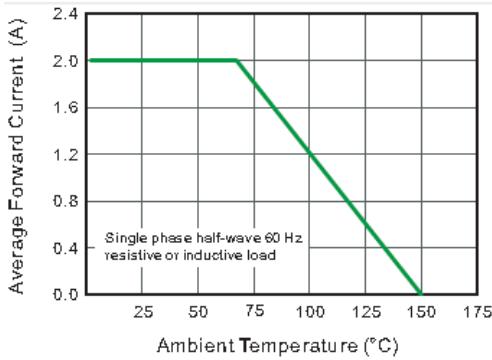

Fig.1 Forward Current Derating Curve

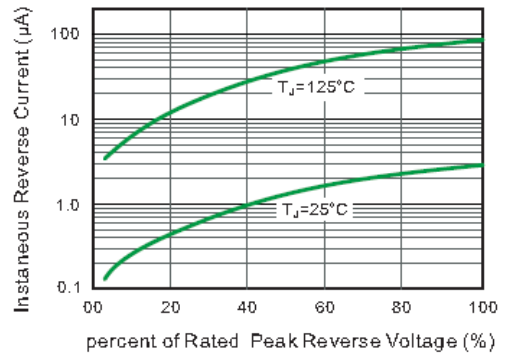

Fig.2 Typical Reverse Characteristics

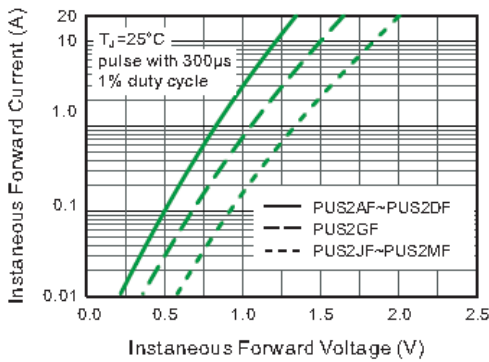

Fig.3 Typical Instantaneous Forward Characteristics

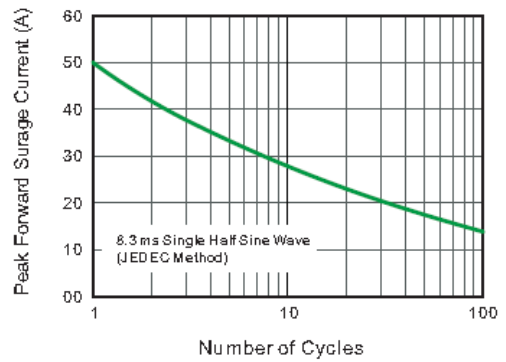
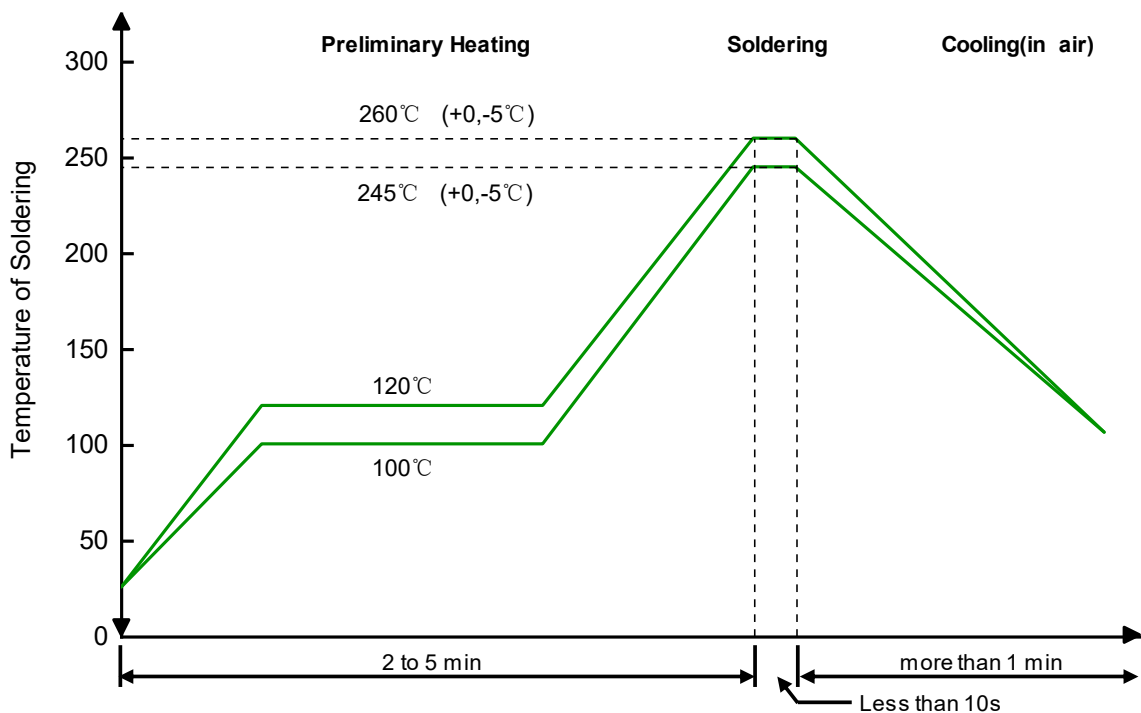

Fig.4 Maximum Non-Repetitive Peak Forward Surge Current

Solder Reflow Recommendation



Remark: Pb free for 260°C; Pb for 245°C.

Product dimension (SMAF)

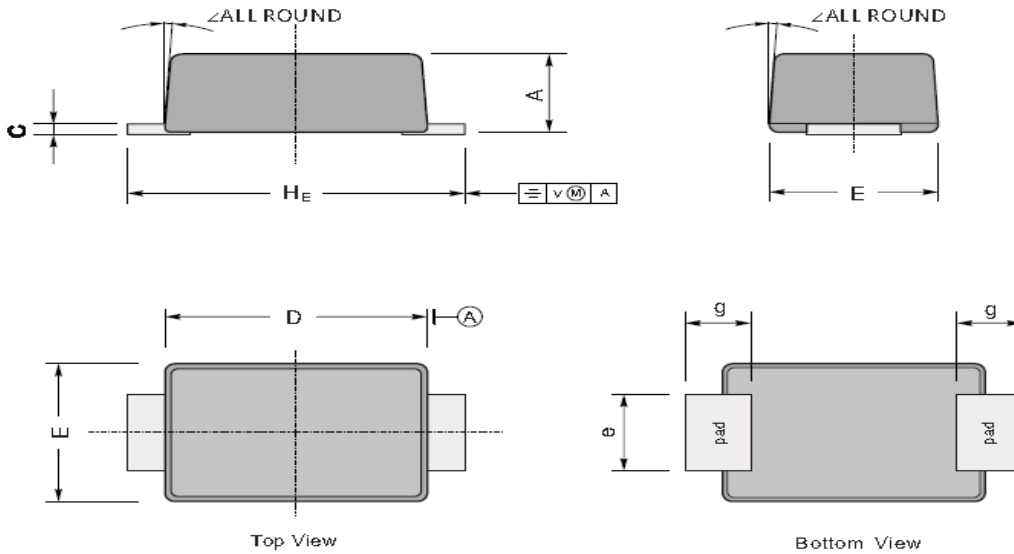

UNIT		A	C	D	E	e	g	H _E	∠
mm	max	1.2	0.23	3.7	2.7	1.6	1.3	4.9	7°
	min	0.9	0.18	3.3	2.4	1.3	1.0	4.4	
mil	max	47	9.1	146	106	63	51	193	
	min	35	7.1	130	94	51	39	173	

The recommended mounting pad size

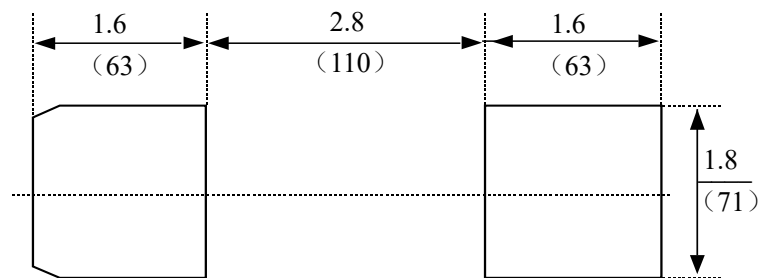

Unit: $\frac{\text{mm}}{(\text{mil})}$

Ordering information

Device	Package	Shipping
PUS2AF-PUS2MF	SMAF	3000/ Tape & Reel

IMPORTANT NOTICE

 and **Prisemi**[®] are registered trademarks of **Prisemi Electronics Co., Ltd (Prisemi)** ,Prisemi reserves the right to make changes without further notice to any products herein. Prisemi makes no warranty, representation or guarantee regarding the suitability of its products for any particular purpose, nor does Prisemi assume any liability arising out of the application or use of any product or circuit, and specifically disclaims any and all liability, including without limitation special, consequential or incidental damages. “Typical” parameters which may be provided in Prisemi data sheets and/or specifications can and do vary in different applications and actual performance may vary over time. All operating parameters, including “Typicals” must be validated for each customer application by customer’s technical experts. Prisemi does not convey any license under its patent rights nor the rights of others. The products listed in this document are designed to be used with ordinary electronic equipment or devices, Should you intend to use these products with equipment or devices which require an extremely high level of reliability and the malfunction of with would directly endanger human life (such as medical instruments, aerospace machinery, nuclear-reactor controllers, fuel controllers and other safety devices), please be sure to consult with our sales representative in advance.

Website: <http://www.prisemi.com>

For additional information, please contact your local Sales Representative.

©Copyright 2009, Prisemi Electronics

 **Prisemi**[®] is a registered trademark of Prisemi Electronics.

All rights are reserved.