

## Description

### MOSFET Product Summary

$V_{DS}(V)$	$R_{DS(on)}(m\Omega)$	$I_D(A)$
650	30@ $V_{GS} = 15V$	70

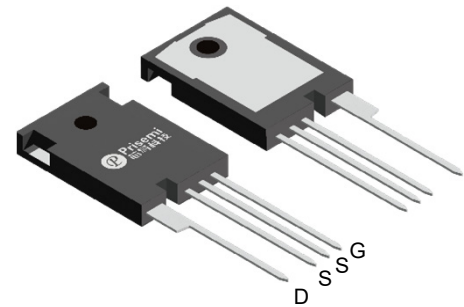

**TO-247-4L**

## Feature

- High Blocking Voltage with Low On-Resistance
- High Frequency Operation
- Low on-resistance
- Fast intrinsic diode with low reverse recovery
- 100% avalanche tested

## Applications

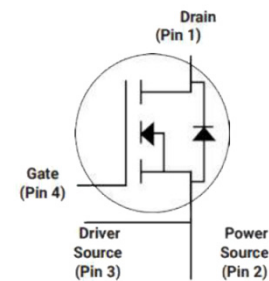
- Solar Inverters
- Switch Mode Power Supplies
- UPS
- Battery Chargers

**Schematic diagram**

## Absolute maximum rating@25°C

Parameter	Symbol	Rating	Unit
Drain-Source Voltage	$V_{DSmax}$	650	V
Gate-Source Voltage (dynamic), $T_{surge} < 100ns$	$V_{GSmax}$	-8/+19	V
Gate-Source Voltage (static)	$V_{GSop}$	-4/+15	V
Continuous Drain Current @ $V_{GS}=15V$	$I_D$	$T_C=25^\circ C$	70
		$T_C=100^\circ C$	49
Pulsed Drain Current	$I_{D(pulse)}$	217	A
Avalanche Energy @ $V_{DD}=100V, V_{GS}=15V, L=1mH$	$E_{AS}$	450	mJ
Avalanche Peak Current @ $V_{DD}=100V, V_{GS}=15V, L=1mH$	$I_{AV}$	30	A
Power Dissipation	$P_D$	246	W
Operating Junction and Storage Temperature	$T_J, T_{STG}$	-55 to +175	°C

## Thermal Resistance

Parameter	Symbol	Min	Typ	Max	Unit
Thermal Resistance, Junction-to-Case	$R_{\theta JC}$	-	0.49	0.61	°C/W

## Electrical characteristics per line@25°C (unless otherwise specified)

Parameter	Symbol	Conditions	Min.	Typ.	Max.	Units	
<b>Statistic Characteristics</b>							
Drain-Source Breakdown Voltage	$V_{(BR)DSS}$	$V_{GS} = 0V, I_D = 100\mu A$	650	-	-	V	
Gate Threshold Voltage	$V_{GS(th)}$	$V_{DS} = V_{GS}, I_D = 10mA$	$T_J = 25^\circ C$	1.8	2.7	3.6	V
			$T_J = 150^\circ C$	-	2.0	-	
			$T_J = 175^\circ C$	-	1.9	-	
Zero Gate Voltage Drain Current	$I_{DSS}$	$V_{DS} = 650V, V_{GS} = 0V$	0.0	1.0	50	$\mu A$	
Gate-Source Leakage Current	$I_{GSS}$	$V_{GS} = 15V, V_{DS} = 0V$	0.0	1.0	200	nA	
		$V_{GS} = -4V, V_{DS} = 0V$	-200	-1.0	0.0		
Drain-Source On-State Resistance	$R_{DS(on)}$	$V_{GS} = 15V, I_D = 30A$	$T_J = 25^\circ C$	-	30	41	m $\Omega$
			$T_J = 150^\circ C$	-	37	-	
			$T_J = 175^\circ C$	-	41	-	
Transconductance	$g_{fs}$	$V_{DS} = 20V, I_D = 30A$	$T_J = 25^\circ C$	-	23	-	S
			$T_J = 150^\circ C$	-	22	-	
			$T_J = 175^\circ C$	-	22	-	
<b>Dynamic Characteristics</b>							
Input Capacitance	$C_{iss}$	$V_{DS} = 400V, V_{GS} = 0V, f = 1MHz$	-	2550	-	pF	
Output Capacitance	$C_{oss}$		-	215	-		
Reverse Transfer Capacitance	$C_{riss}$		-	6.0	-		
$C_{oss}$ Stored Energy	$E_{oss}$		-	21	-		$\mu J$
Total Gate Charge	$Q_g$	$V_{DS} = 400V, I_D = 30A, V_{GS} = -4V/+15V$	-	111	-	nC	
Gate-Source Charge	$Q_{gs}$		-	32	-		
Gate-Drain Charge	$Q_{gd}$		-	41	-		
Internal Gate Input Resistance	$R_{G(int)}$	$f = 1MHz, I_D = 0A$	-	0.8	-	$\Omega$	
Turn-On Switching Energy	$E_{on}$	$V_{DS} = 400V, I_D = 30A, V_{GS} = -4V/+15V, R_{G(ext)} = 2\Omega, L = 100\mu H$	-	110	-	$\mu J$	
Turn-Off Switching Energy	$E_{off}$		-	15	-		
Turn-on Delay Time	$t_{d(on)}$	$V_{DS} = 400V, I_D = 30A, V_{GS} = -4V/+15V, R_{G(ext)} = 2\Omega, L = 100\mu H$	-	14	-	ns	
Turn-on Rise Time	$t_r$		-	17	-		
Turn-Off Delay Time	$t_{d(off)}$		-	27	-		
Turn-Off Fall Time	$t_f$		-	7.0	-		
<b>Reverse Diode Characteristics</b>							
Diode Forward Voltage	$V_{SD}$	$V_{GS} = -4V, I_{SD} = 15A$	$T_J = 25^\circ C$	-	4.5	-	V
			$T_J = 150^\circ C$	-	4.1	-	
			$T_J = 175^\circ C$	-	4.0	-	
		$V_{GS} = -4V, I_{SD} = 30A$	$T_J = 25^\circ C$	-	5.1	-	
			$T_J = 150^\circ C$	-	4.7	-	
			$T_J = 175^\circ C$	-	4.6	-	
Continuous Diode Forward Current	$I_S$	$V_{GS} = -4V$	-	-	41	A	
Reverse Recovery Time	$t_{rr}$	$V_{GS} = -4V, I_{SD} = 30A, V_R = 400V, dif/dt = 3300A/\mu s$	-	15	-	ns	
Reverse Recovery Charge	$Q_{rr}$		-	198	-	nC	
Peak Reverse Recovery Current	$I_{rrm}$		-	23	-	A	

Typical Characteristics

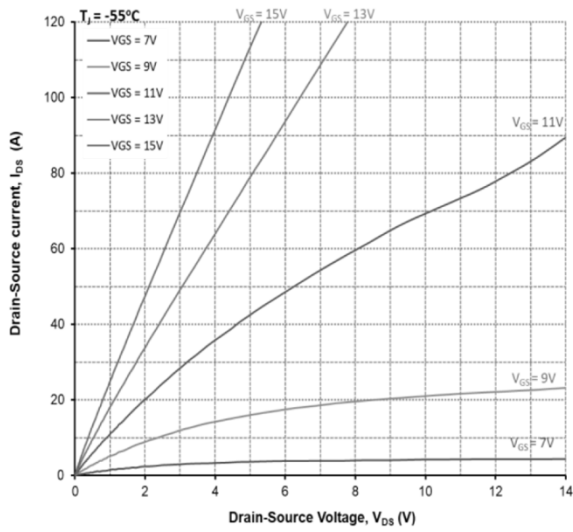

Figure 1. Output Characteristics,  $T_J = -55^\circ\text{C}$

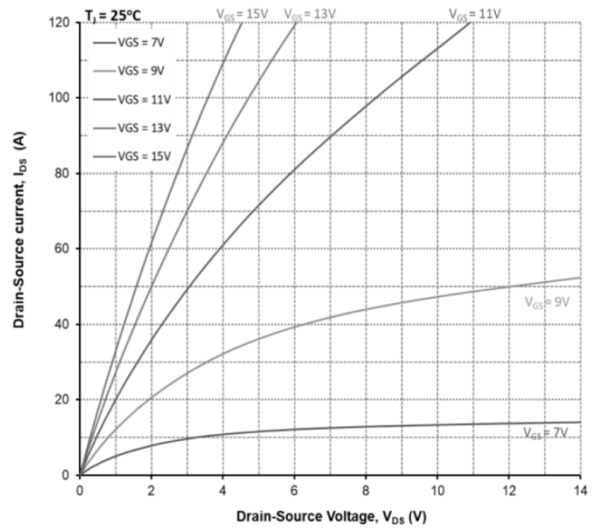

Figure 2. Output Characteristics,  $T_J = 25^\circ\text{C}$

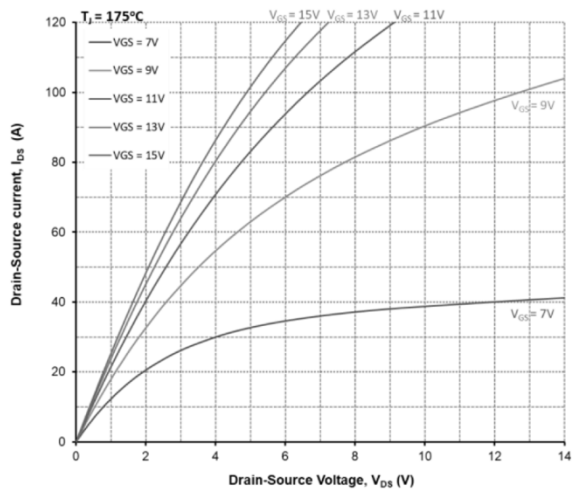

Figure 3. Output Characteristics,  $T_J = 175^\circ\text{C}$

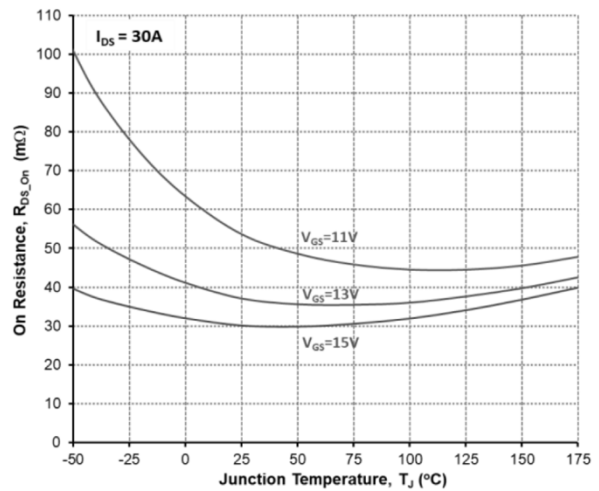

Figure 4. On-Resistance vs. Temperature

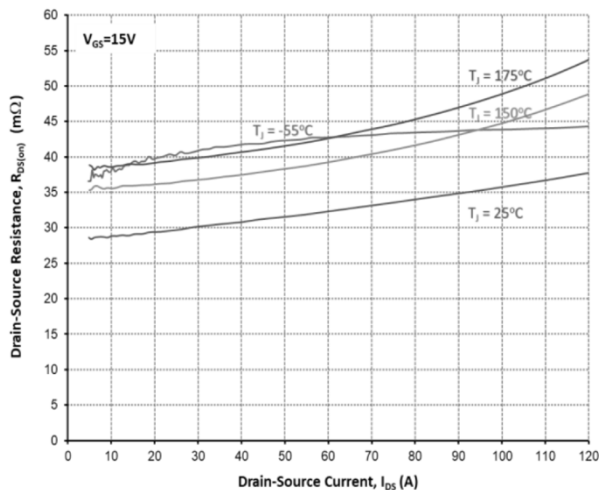

Figure 5. On-Resistance vs. Drain Current For Various Temperatures

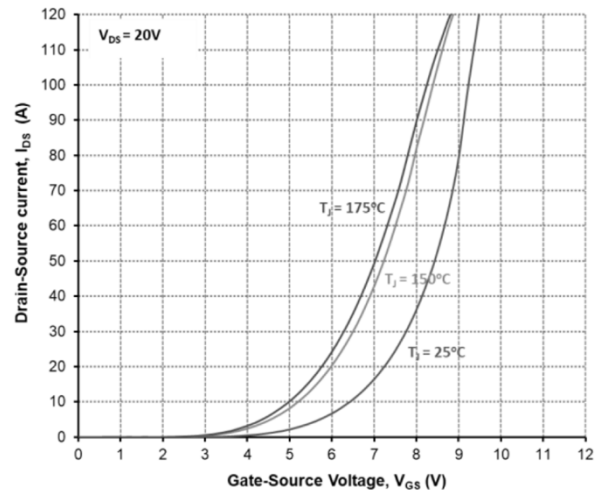

Figure 6. Transfer Characteristic For Various Junction Temperatures

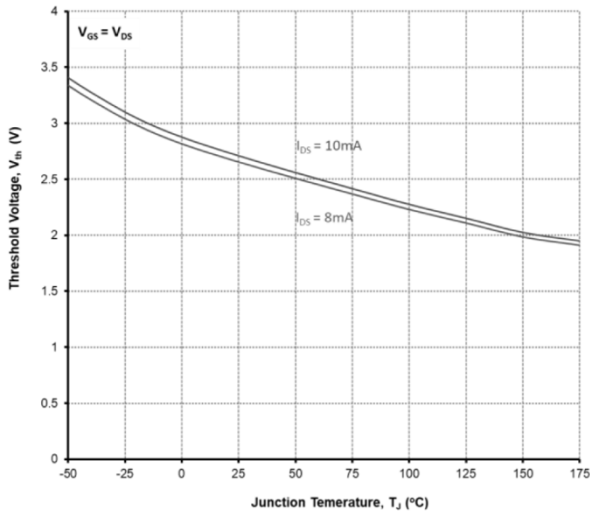

Figure 7. Threshold Voltage vs. Temperature

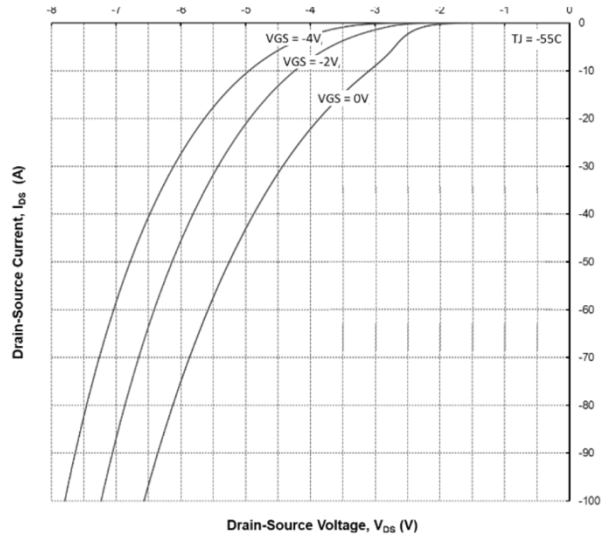

Figure 8. Body Diode Characteristics @ -55°C

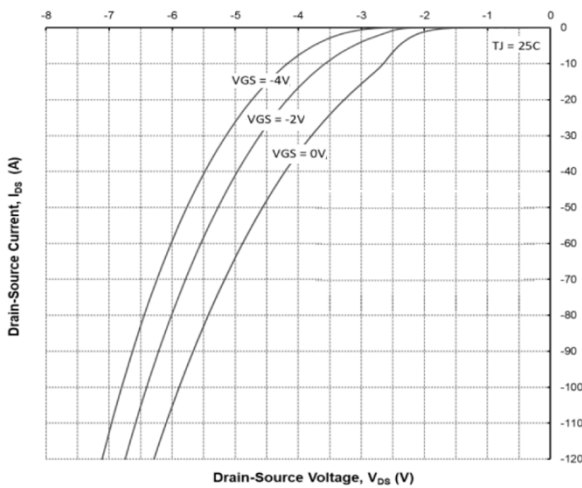

Figure 9. Body Diode Characteristics @ 25°C

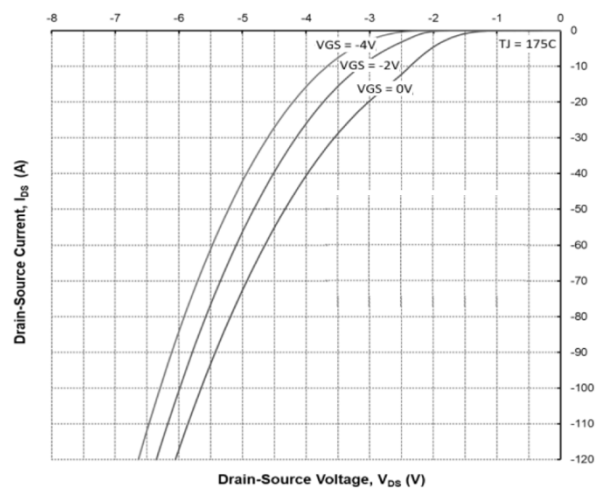

Figure 10. Body Diode Characteristics @ 175°C

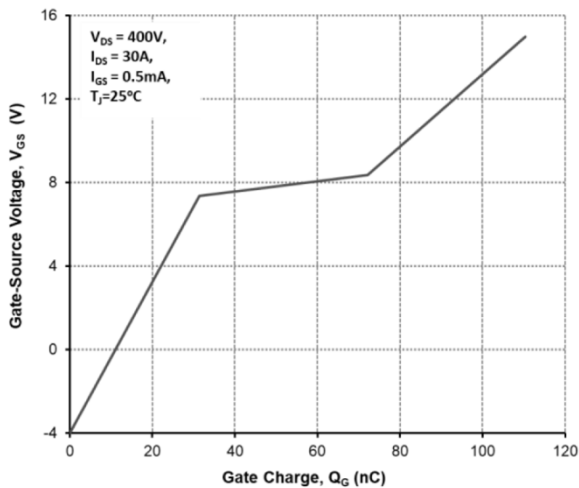

Figure 11. Gate Charge Characteristics

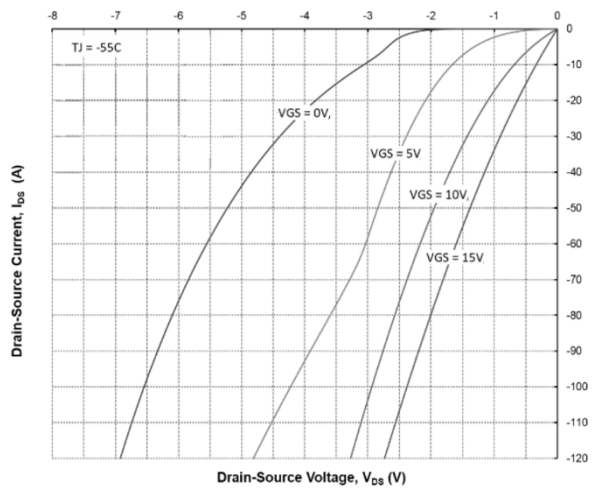

Figure 12. 3<sup>rd</sup> Quadrant Characteristics @ -55°C

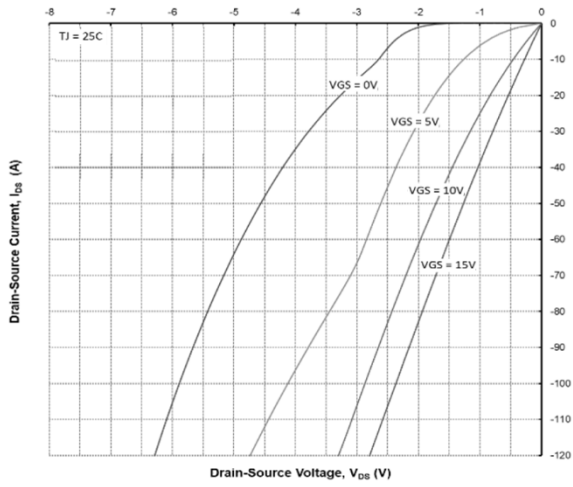

Figure 13. 3<sup>rd</sup> Quadrant Characteristics @ 25°C

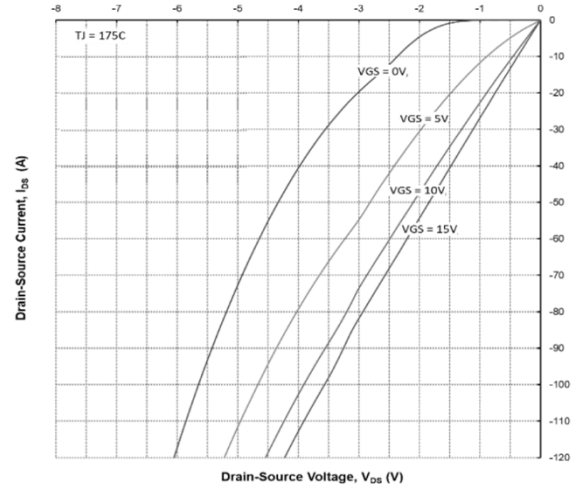

Figure 14. 3<sup>rd</sup> Quadrant Characteristics @ 175°C

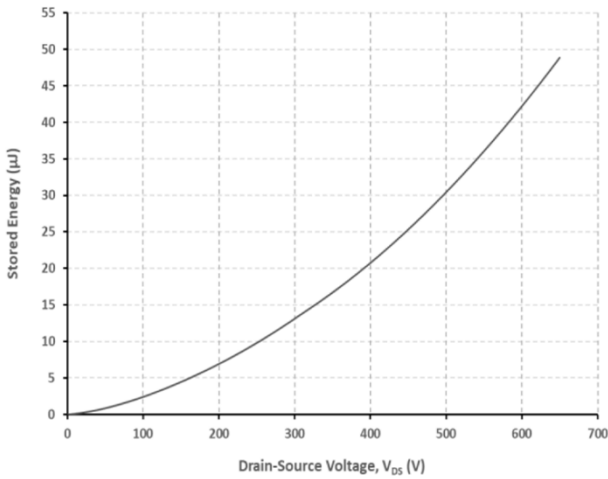

Figure 15. Output Capacitor Stored Energy

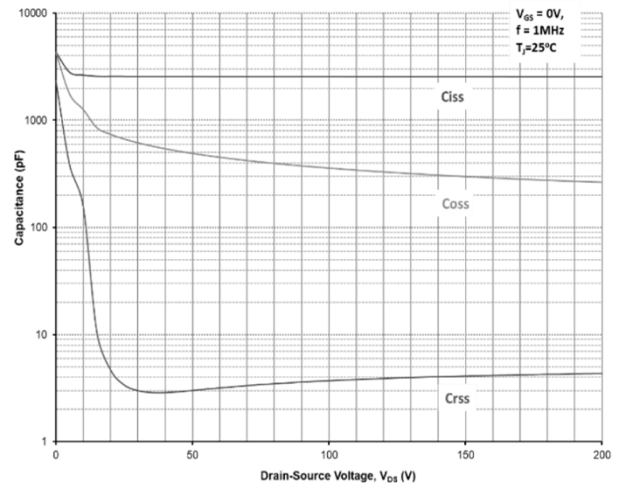

Figure 16. Capacitances vs. Drain-Source Voltage (0-200V)

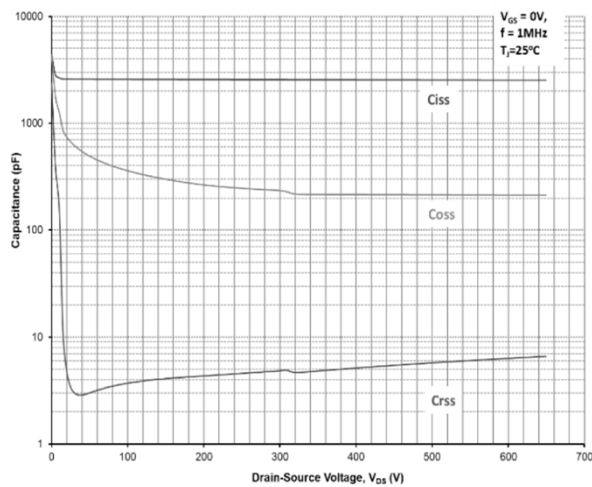

Figure 17. Capacitances vs. Drain-Source Voltage (0-650V)

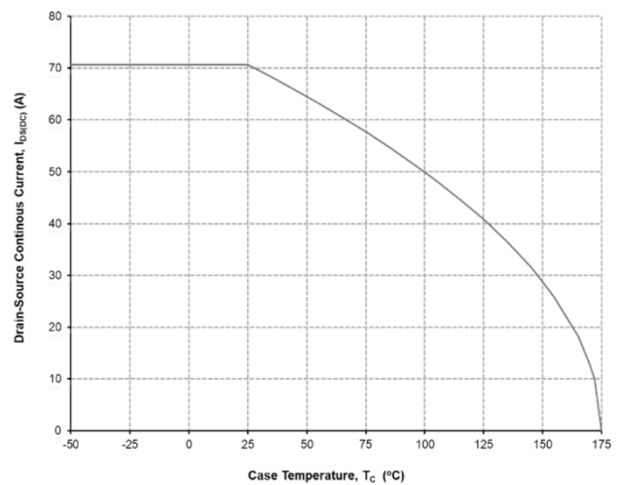

Figure 18. Continuous Drain Current Derating vs. Case Temperature

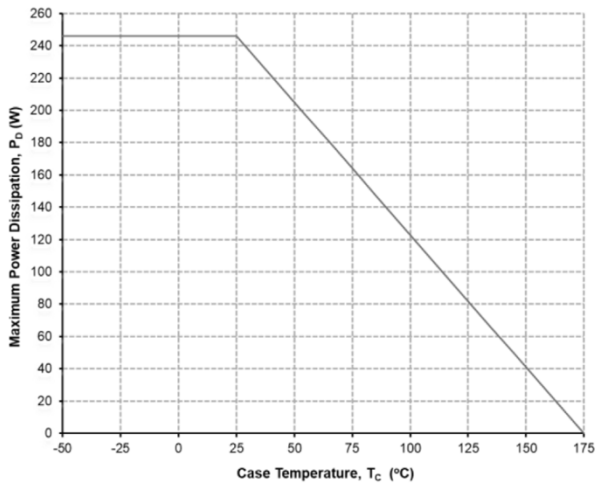

Figure 19. Maximum Power Dissipation Derating vs. Case Temperature

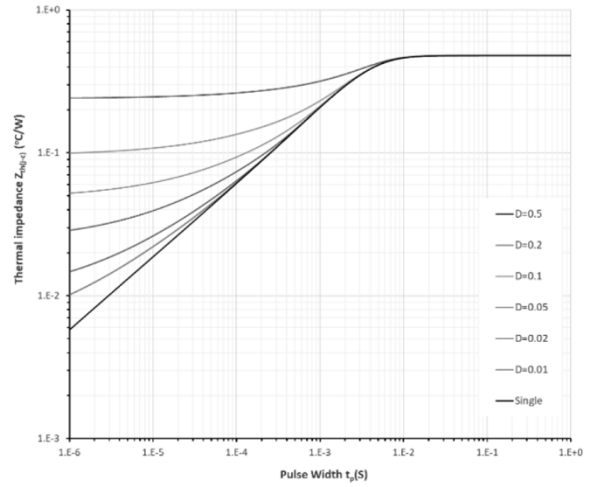

Figure 20. Transient Thermal Impedance (Junction to Case)

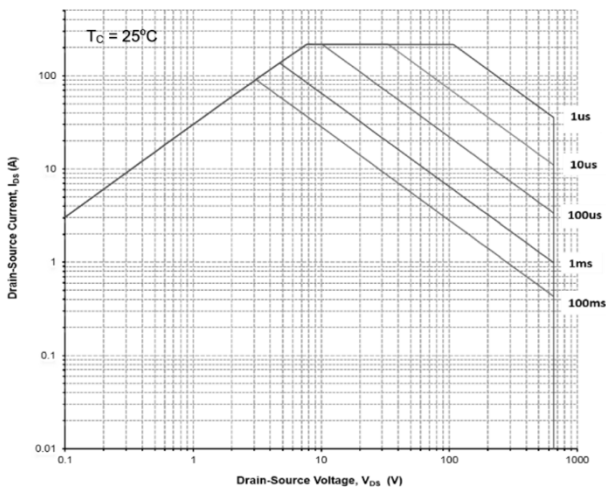

Figure 21. Safe Operating Area

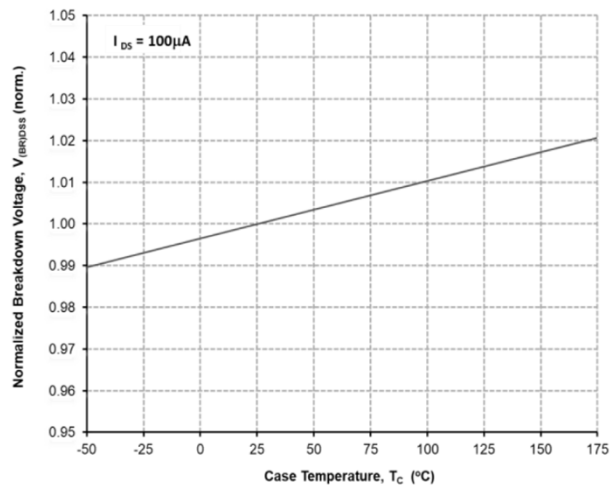

Figure 22. Normalized breakdown voltage vs Temperature

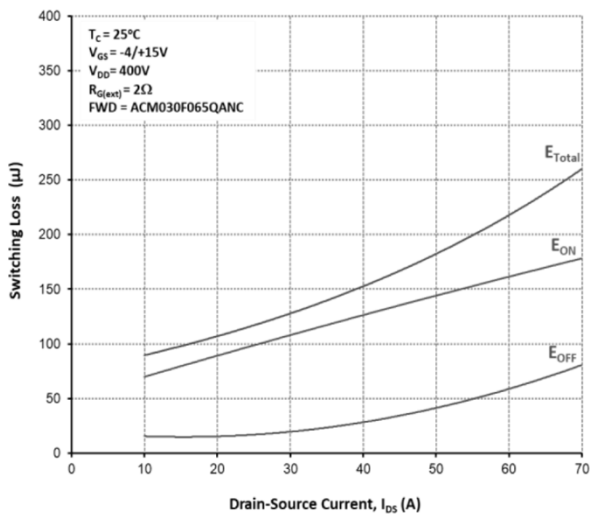

Figure 23. Switching energy vs Drain current

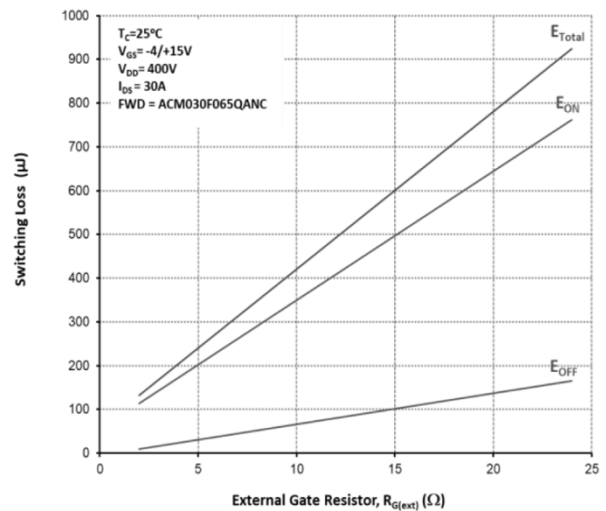
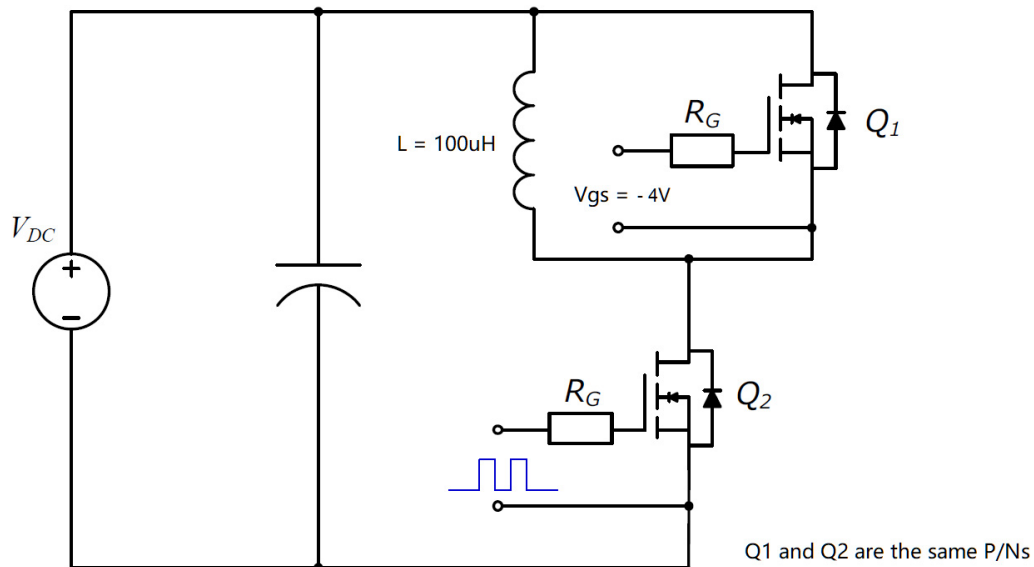
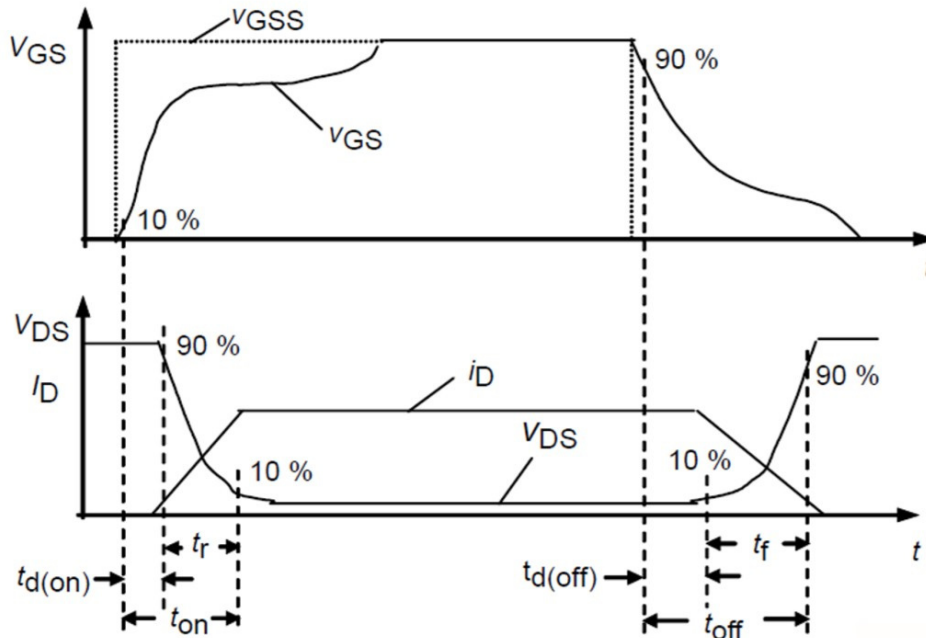
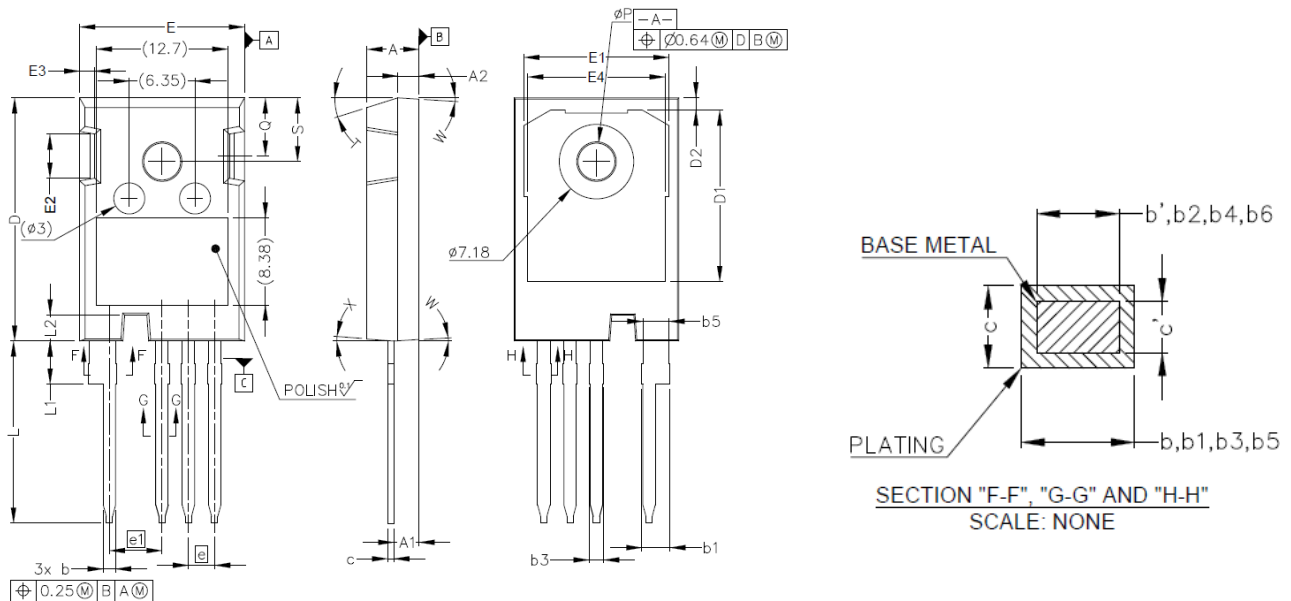

Figure 24. Switching energy vs External Gate Resistor

Switching Times Definition and Test Circuit



## Product dimension (TO-247-4L)



Dim	Millimeters		Inches		Dim	Millimeters		Inches	
	Min	Max	Min	Max		Min	Max	Min	Max
A	4.83	5.21	0.190	0.205	E1	13.10	14.15	0.516	0.557
A1	2.29	2.54	0.090	0.100	E2	3.68	5.10	0.145	0.201
A2	1.91	2.16	0.075	0.085	E3	1.00	1.90	0.039	0.075
b'	1.07	1.28	0.042	0.050	E4	12.38	13.43	0.487	0.529
b	1.07	1.33	0.042	0.052	e	2.54 BSC		0.100 BSC	
b1	2.39	2.94	0.094	0.116	e1	5.08 BSC		0.200 BSC	
b2	2.39	2.84	0.094	0.112	N	4.00		0.157	
b3	1.07	1.60	0.042	0.063	L	17.31	17.82	0.681	0.702
b4	1.07	1.50	0.042	0.059	L1	3.97	4.37	0.156	0.172
b5	2.39	2.69	0.094	0.106	L2	2.35	2.65	0.093	0.104
b6	2.39	2.64	0.094	0.104	φP	3.51	3.65	0.138	0.144
c'	0.55	0.65	0.022	0.026	Q	5.49	6.00	0.216	0.236
c	0.55	0.68	0.022	0.027	S	6.04	6.30	0.238	0.248
D	23.30	23.60	0.917	0.929	T	17.5° Ref.		17.5° Ref.	
D1	16.25	17.65	0.640	0.695	W	3.5° Ref.		3.5° Ref.	
D2	0.95	1.25	0.037	0.049	X	4° Ref.		4° Ref.	
E	15.75	16.13	0.620	0.635					



**IMPORTANT NOTICE**

 and **Prisemi**<sup>®</sup> are registered trademarks of **Prisemi Electronics Co., Ltd** (Prisemi), Prisemi reserves the right to make changes without further notice to any products herein. Prisemi makes no warranty, representation or guarantee regarding the suitability of its products for any particular purpose, nor does Prisemi assume any liability arising out of the application or use of any product or circuit, and specifically disclaims any and all liability, including without limitation special, consequential or incidental damages. "Typical" parameters which may be provided in Prisemi data sheets and/or specifications can and do vary in different applications and actual performance may vary over time. All operating parameters, including "Typicals" must be validated for each customer application by customer's technical experts. Prisemi does not convey any license under its patent rights nor the rights of others. The products listed in this document are designed to be used with ordinary electronic equipment or devices, Should you intend to use these products with equipment or devices which require an extremely high level of reliability and the malfunction of with would directly endanger human life (such as medical instruments, aerospace machinery, nuclear-reactor controllers, fuel controllers and other safety devices), please be sure to consult with our sales representative in advance.

Website: <http://www.prisemi.com>

For additional information, please contact your local Sales Representative.

©Copyright 2009, Prisemi Electronics

 **Prisemi**<sup>®</sup> is a registered trademark of Prisemi Electronics.

All rights are reserved.